



INSTRUCTIONS D'ASSEMBLAGE
ASSEMBLY INSTRUCTIONS

MONARCH
SPECIALTIES INC.

I 3047

TABLE D'APPOINT -
NOIR LUSTRE / ARGENT / VERRE TREMPE

ACCENT TABLE -
GLOSSY BLACK / SILVER WITH TEMPERED GLASS





**POUR DE L'ASSISTANCE OU POUR COMMANDER
DES PIÈCES CONTACTEZ NOTRE DÉPARTEMENT
DE SERVICE À LA CLIENTÈLE.**

**FOR ASSISTANCE OR TO ORDER PARTS
CONTACT OUR CUSTOMER SERVICE DEPARTMENT**

WWW.MONARCHSERVICE.COM

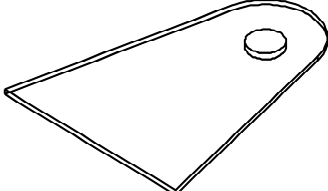
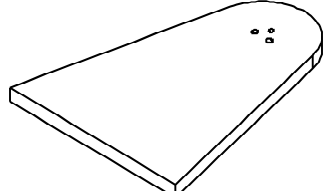
LISTE DES PIÈCES
PARTS LIST

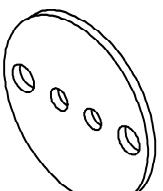
PIÈCE / PART #	IMAGE	DESCRIPTION	QTY / QTÉ
1		<p align="center">GLASS TOP SURFACE EN VERRE</p>	1
2		<p align="center">BOTTOM PANEL PANNEAU DU BAS</p>	1
3		<p align="center">SUPPORT BAR BARRE DE SOUTIEN</p>	1
4		<p align="center">METAL PLATE PLAQUE EN MÉTAL</p>	1

LISTE DES PIÈCES DE MONTAGE
HARDWARE LIST

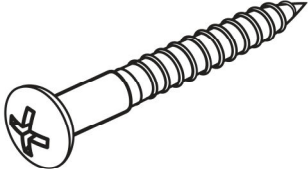
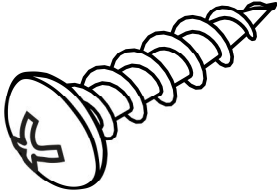
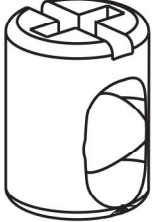
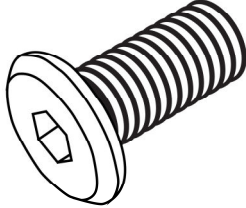
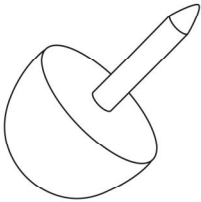
PIÈCE / PART #	IMAGE	DESCRIPTION	QTY / QTÉ
A		<p>ASSEMBLING SCREW - Ø1/4" X 1 1/2"</p> <p>VIS D'ASSEMBLAGE - Ø1/4" X 1 1/2"</p>	2
B		<p>ASSEMBLING SCREW - Ø3/8" X 1"</p> <p>VIS D'ASSEMBLAGE - Ø3/8" X 1"</p>	1
C		<p>BARREL NUT - Ø3/8" X 1/2"</p> <p>ÉCROU DE CANON - Ø3/8" X 1/2"</p>	2
D		<p>ASSEMBLING BOLT - Ø1/4" X 3/8"</p> <p>BOULON D'ASSEMBLAGE - Ø1/4" X 3/8"</p>	2
E		<p>FLOOR PROTECTOR - Ø5/8"</p> <p>PROTECTEUR DE PLANCHER - Ø5/8"</p>	4

LISTE DES PIÈCES DE MONTAGE
HARDWARE LIST

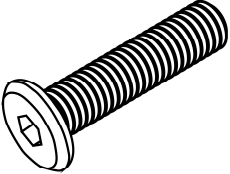
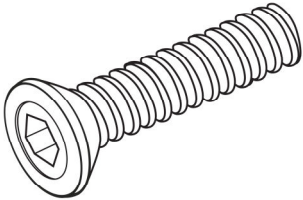
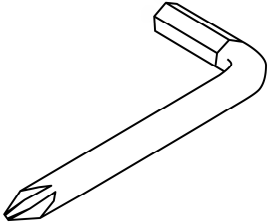
PIÈCE / PART #	IMAGE	DESCRIPTION	QTY / QTÉ
F		<p align="center">ASSEMBLING BOLT - Ø1/4" X 2 1/4" BOULON D'ASSEMBLAGE - Ø1/4" X 2 1/4"</p>	1
G		<p align="center">ASSEMBLING BOLT - Ø1/4" X 1 3/8" BOULON D'ASSEMBLAGE - Ø1/4" X 1 3/8"</p>	1
H		<p align="center">HEX KEY CLÉ HEXAGONALE</p>	1



OUTIL DE VÉRIFICATION DE DIMENSIONS DES PIÈCES
HARDWARE DIMENSIONS VERIFICATION TOOL



ÉTAPE / STEP 1

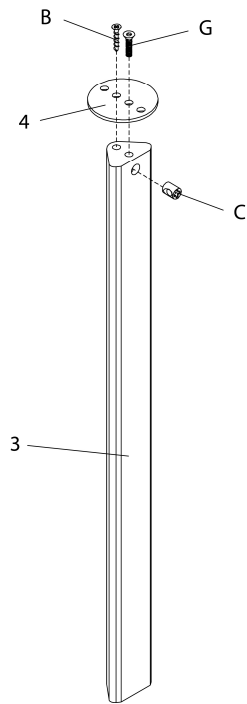

ÉTAPE / STEP 2

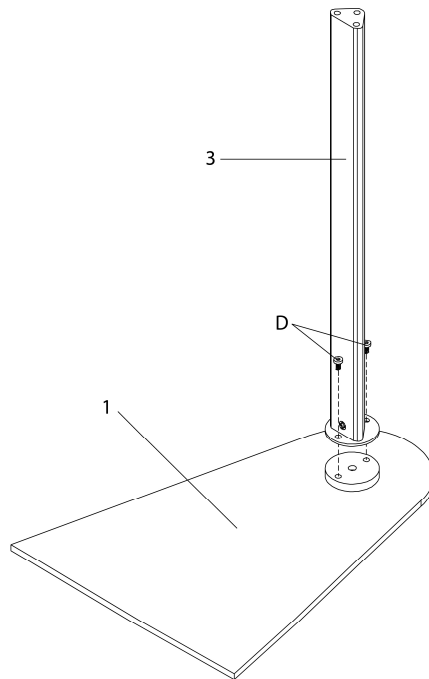

ÉTAPE / STEP 3

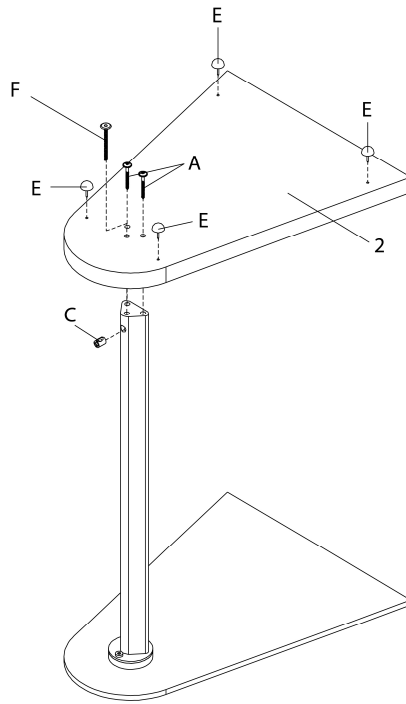

ÉTAPE / STEP 4

